

Data Sheet



Article number: 021500700100

Description: Sealing Clamp S 100 W5

Measures

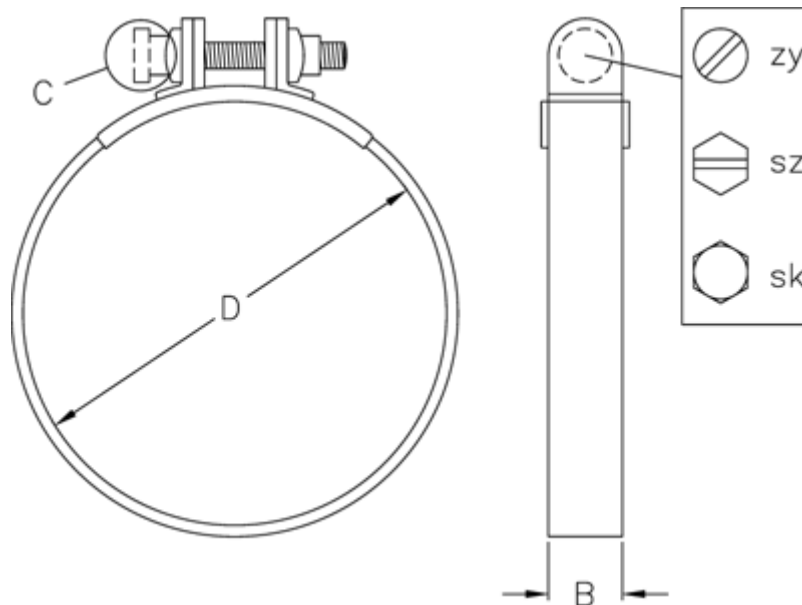

C (screw type) = SZ

Diameter D = 100

Width B = 20